



# FLOWSIC600 DRU

ULTRASONIC GAS FLOW METER FOR UPSTREAM APPLICATIONS

Gas flow meters

**SICK**  
Sensor Intelligence.

# UPSTREAM MEETS ULTRASONIC – REACHING A NEW MILESTONE IN RANGEABILITY & REDUCED MAINTENANCE COSTS

Ultrasonic meters provide several advantages over differential pressure meters such as improved rangeability, a higher turndown, no calibration and valuable diagnostics. The FLOWSIC600 DRU, an innovative dual-path ultrasonic meter is tailor-made for upstream and gathering applications. Specially adapted sensors and path layout combines the benefits of a FLOWSIC600 with an unmatched reliability and robustness for upstream conditions. The integrated 10D upstream piping allows for high measurement accuracy even without high-pressure calibration, resulting in faster ROI due to the lower operational costs of a virtually maintenance-free meter.

FLOWSIC600 DRU – improved quality in upstream gas metering.



## Advanced diagnostics give you an advantage

The FLOWSIC600 DRU introduces a new diagnostic feature for the detection of liquids in the gas stream. Indication is typically provided when the gas volume fraction falls below 99.5%. This feature can provide valuable information about the measurement quality and the performance of upstream components such as liquid separators. Additional diagnostic information can be monitored, which gives the user information about how the meter and the meter run is performing. The additional parameters for each path are: the speed of sound, turbulence, the automatic gain control value, the signal validity parameter and analysis of the actual raw signal wave forms.

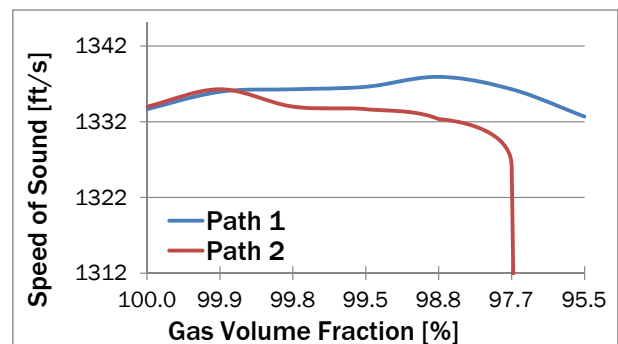

- The FLOWSIC600 DRU provides "real-time" monitoring of all diagnostic parameters, informs about the measurement conditions and generates a warning when parameters change significantly.
- Special design features ensure the FLOWSIC600 DRU is rugged even in wet gas conditions.
- Due to the decreased necessity for on-site checks and cleanings, your operating expenses stay low.



### Rangeability and turndown

With a turndown ratio of up to 150:1<sup>1</sup> it covers flow ranges that usually require several differential pressure meters in different sizes. Diagnostics monitor the meter and process conditions, so that even large variations in flow and gas quality will not affect the measurement availability, which gives you peace of mind for natural gas production and gathering environments. By verifiable savings in CapEx and OpEx and less effort for maintenance, FLOWSIC600 DRU is an ideal alternative to differential pressure meters.

<sup>1</sup>Below 3 ft/s increased uncertainty

### Long term stability

The FLOWSIC600 DRU keeps your costs low with long maintenance-free operating periods and high availability even in wet gas conditions. A high turndown ratio ensures reliable readings even with large variations in flow. Finally, the direct path layout is insensitive against pipeline fouling and further reduces maintenance effort, which underlines the long-term economic advantages of FLOWSIC600 DRU.

### Virtually maintenance-free with self diagnostics

Ultrasonic technology is free of moving parts and has no wear and tear. Equipped with the MEPAFLOW CBM firmware and software, FLOWSIC600 DRU monitors itself and processes changes using “real-time” monitoring of all diagnostic meter parameters. The innovative liquid loading detection feature provides indication of liquids inside the gas stream and allows you to optimize the process and plan maintenance of the FLOWSIC600 DRU and other devices accordingly.

### Highly durable

The FLOWSIC600 DRU is designed for use in harsh upstream environments. High durability is made possible by hermetically sealed transducers made of titanium with special wet gas encapsulation, and a meter body that ensures that liquids and contaminants will not affect the meter performance. Also, the integral meter design with sealed transducer cover and internal cable routing prevent harsh ambient conditions from harming the device. This gives you the certainty of meter longevity even in challenging conditions.

### High accuracy without high-pressure calibration

The integrated 10D inlet, superior manufacturing precision, extremely tight tolerances for each meter during the manufacturing process, and high quality components all enable the SICK FLOWSIC600 DRU to ensure a  $\pm 1\%$  uncertainty without calibration. By eliminating the need for calibration, this feature alone can save start-up time and cost.

### Profit from technology leadership in ultrasonic gas metering

SICK is the technology leader in ultrasonic gas measurement. We have more than 30 years experience in ultrasonic measurement technology and more than 10 years of field experience with FLOWSIC600 in various applications. This knowledge has now been transferred into FLOWSIC600 DRU in order to provide a suiting solution even for upstream measurements. Our customers rely on us when it comes to challenging applications – with FLOWSIC600 DRU they can do as well.

# STEPS TO ACCURACY: 1 % UNCERTAINTY WITHOUT HIGH-PRESSURE CALIBRATION

In combination with SICK's leading ultrasonic transducer technology, continuous manufacturing process improvements, and our certified in-house calibration lab SICK offers a high level of production quality unmatched by anyone. Because of this, our manufacturing process for the FLOWSIC600 DRU results in a  $\pm 1\%$  uncertainty out-of-the-box performance without the need for high-pressure calibration.

During manufacturing of the FLOWSIC600 DRU there are five essential steps that are worth taking a closer look at:

## Manufacturing precision

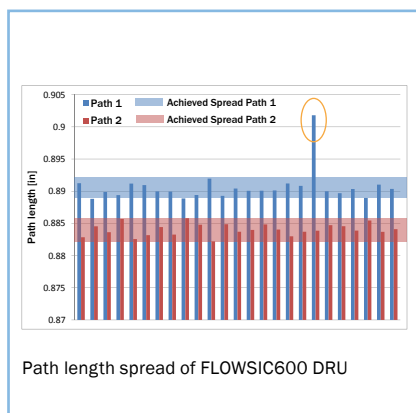

It starts with the meter body. Superior manufacturing precision and narrow tolerance limits ensure the utmost accuracy of geometric parameters of the meter body and its integrated 10D inlet piping. Long-term collaborations with our regional suppliers allow a thorough quality assurance level for all the high-quality components of the FLOWSIC600 DRU.

## Superior transducer technology

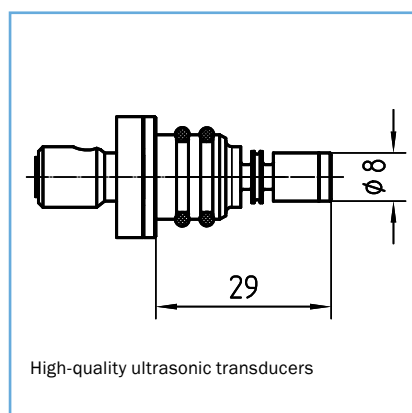

High-quality transducers are the heart of our intelligent measurement devices. All transducers are made of titanium, are hermetically sealed without a matching layer and wet gas protected. SICK transducers are subject to precise geometrical dimensional and impedance checks before they are matched pairwise to provide the utmost accuracy on each ultrasonic path for superior performance.

## Zero flow verification test

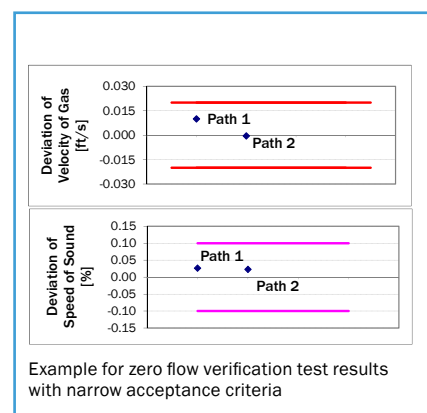

After assembly of the meter, a zero flow verification test is performed to verify proper transit-time measurement. Zero flow stability dominantly affects a meter's low-flow performance. The acceptance criteria for FLOWSIC600 zero flow verification exceeds the requirements from AGA9, and therefore ensures good low-flow performance.



### Individual low-pressure calibration

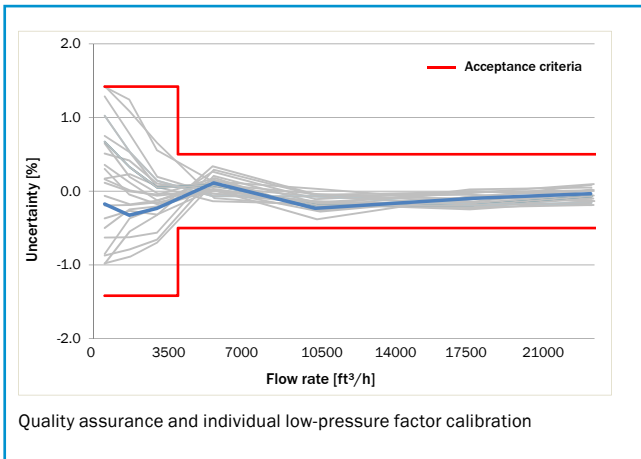

Each FLOWSIC600 DRU is subject to a 7-point ambient air low pressure calibration. Calibration is done on SICK's in-house test benches, which are certified and traceable by Germany's national metrology institute, PTB. Quality acceptance criteria for the resulting meter characteristics ultimately ensure proper meter performance. Based on the calibration result and thorough statistical methods, each meter is individually corrected by calibration factors (based on flow-weighted mean error calculation).

### In-process quality assurance for high-pressure performance

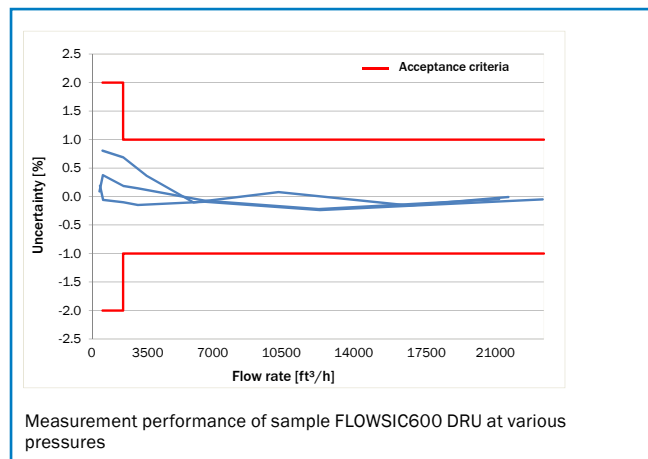

Extensive testing was conducted during the development process of FLOWSIC600 DRU in order to create a good and repeatable correlation between low-pressure and high-pressure meter performance. To ensure the proper performance of each FLOWSIC600 DRU under high-pressure conditions in series production, permanent quality assurance measures have been installed. Population samples are periodically sent to certified high-pressure calibration labs to verify statistical treatment is relevant to the population. This increases the population database and ultimately decreases measurement uncertainty.

# ULTRASONIC GAS FLOW METER FOR UPSTREAM APPLICATIONS



## Additional information

Fields of application . . . . .7  
 Detailed technical data . . . . .7  
 Ordering information . . . . .8  
 Dimensional drawings . . . . .8  
 Application range . . . . .9  
 Installation instructions . . . . .9

## Product description

The FLOWSIC600 DRU is an innovative ultrasonic dual-path gas meter for upstream applications based on the FLOWSIC600. The meter includes a 10D inlet piping. With a turndown ration of up to 150:1<sup>1</sup> it covers common flow ranges that usually require several orifice plates. Due to its special design, the FLOWSIC600 DRU provides low measurement uncertainty without need for a high-pressure flow calibration.

High quality components with superior manufacturing precision and wet gas resistant transducers ensure long-term measurement reliability even in challenging conditions. Equipped with MEPAFLOW600 CBM firmware and software, the FLOWSIC600 DRU provides advanced diagnostic capabilities for real-time monitoring of the meter and the process. The ultrasonic measurement principle with direct path layout makes FLOWSIC600 DRU virtually maintenance-free – even with high liquid loads.

<sup>1</sup> Below 3 ft/s increased uncertainty

## At a glance

- 3 inch and 4 inch dual-path ultrasonic meter with integrated 10D inlet piping
- High quality components with superior manufacturing precision
- High turndown ratio covering typical flow ranges of multiple orifice meters
- Accurate to ± 1 % without a high - pressure flow calibration
- Transducers designed for wet gas applications
- MEPAFLOW600 CBM firmware and software
- New diagnostic feature to detect liquid loads
- Virtually maintenance-free – even with high liquid loads

## Your benefits

- Low initial CapEx – FLOWSIC600 DRU is accurate without need for expensive flow calibration
- Low subsequent CapEx by high turndown – FLOWSIC600 DRU can cover typical measurement ranges of multiple orifice meters (no need for station resize or replacement of orifice plates)
- Low OpEx by long maintenance-free operating period with stable accuracy - even in wet gas applications
- Low OpEx by a high turndown – no need for plate replacement, and only clean when the need is indicated by the diagnostics
- High measurement reliability using "real-time" monitoring of all diagnostic meter parameters
- Advanced process monitoring capability with unique liquid load detection
- Better measurement accuracy than orifice meters in wet gas conditions
- Long life-span - encapsulated transducers are not affected by liquids and contaminants

→ [www.mysick.com/en/FLWSIC600](http://www.mysick.com/en/FLWSIC600)

For more information, just enter the link and get direct access to technical data, CAD design models, operating instructions, software, application examples and much more.

## Fields of application

- Upstream natural gas metering in production and gathering
- Multi-Well production pad meters
- Shale gas production
- Natural gas transfer with possible wet gas content
- Check metering
- Allocation metering
- Replacement of orifice meter installations

## Detailed technical data

The exact device specifications and performance data of the product may deviate from the information provided here, and depend on the application in which the product is being used and the relevant customer specifications.

## System

<b>Measured values</b>	Operational volume flow, operational volume, gas velocity, sound velocity					
<b>Measurement principle</b>	Ultrasonic transit time difference measurement					
<b>Number of measuring paths</b>	2					
<b>Measuring medium</b>	Natural gas					
<b>Measuring ranges</b>	Operational:					
	$Q_{min}^1$		$Q_t$		$Q_{max}^2$	
	3 inch	4 inch	3 inch	4 inch	3 inch	4 inch
Flow velocity [ft/s]	3	3	10	10	150	122
Volume flow rate [m <sup>3</sup> /h]	14	25	47	81	700	1000
Volume flow rate [ft <sup>3</sup> /h]	495	860	1650	2875	24770	35000
	<sup>1</sup> Below 3 ft/s increased uncertainty.					
	<sup>2</sup> $Q_{max}$ can be limited by the working pressure and attenuation of the gas medium.					
<b>Repeatability</b>	± 0.2 % of reading (within $Q_t$ to $Q_{max}$ under consideration of installation requirements)					
<b>Uncertainty</b>	± 1 % from $Q_t$ to $Q_{max}$ (± 2 % from $Q_{min}$ to $Q_t$ )					
<b>Gas temperature</b>	-40 ... 185 °F					
<b>Operating pressure</b>	0 ... 1480 psig at 100 °F 0 ... 1380 psig at 185 °F					
<b>Nominal pipe size</b>	3 inch Schedule 80 / 4 inch Schedule 80					
<b>Flange connection</b>	3 inch ANSI B16.5, Cl.600 RF / 4 inch ANSI B16.5, Cl.600 RF					
<b>Ambient temperature</b>	-40 ... 140 °F					
<b>Storage temperature</b>	-40 ... 158 °F					
<b>Ambient humidity</b>	≤ 95 % Relative humidity					
<b>Ex approvals</b>						
	NEC/CEC	Class I, Division 1, Group D T4 Class I, Division 2, Group D T4 Ultrasonic transducers intrinsically safe				
<b>Enclosure rating</b>	IP66/IP67					
<b>Digital outputs</b>	2 DO and 1 FO: 30 V, 10 mA Passive, galvanically isolated, open collector, $f_{max} = 6$ kHz (scalable)					
<b>Interfaces</b>	RS-485 (2x, for configuration data output and diagnosis)					
<b>Bus protocol</b>	MODBUS ASCII, MODBUS RTU					
<b>Dimensions (W x H x D)</b>	See dimensional drawings					
<b>Weight</b>	3 inch: 105.8 lbs (48 kg); 4 inch: 187.4 lbs (85 kg)					
<b>Electrical connection</b>						
	Voltage	12 ... 28.8 V DC				
	Power consumption	≤ 1 W				



## Ordering information

Our regional sales organization will help you to select the optimum device configuration.

## Dimensional drawings (Dimensions in mm [inch])

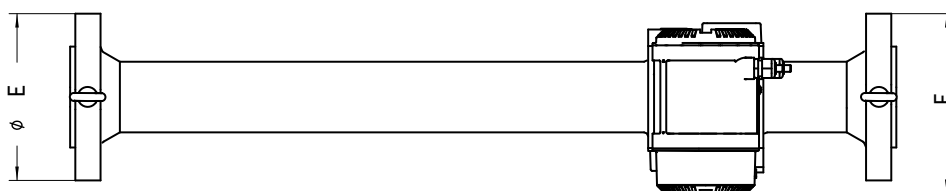
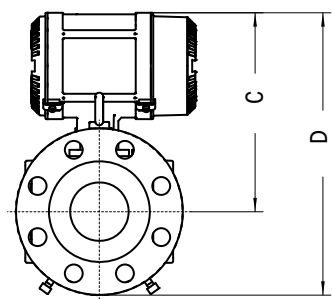
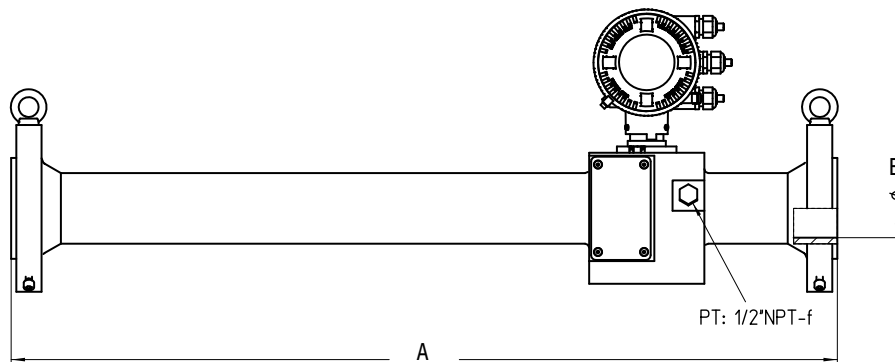

Nominal size	Dimensions					
	A	B	C	D	E	F
3 inch	1040 (40.94)	73.66 (2.90)	250.5 (9.86)	355.5 (14.00)	210 (8.27)	226.3 (8.91)
4 inch	1300 (51.18)	97.18 (3.83)	259 (10.20)	396 (15.60)	275 (10.83)	258.8 (10.19)

**All dimensions in mm (inch).**



## Application Range

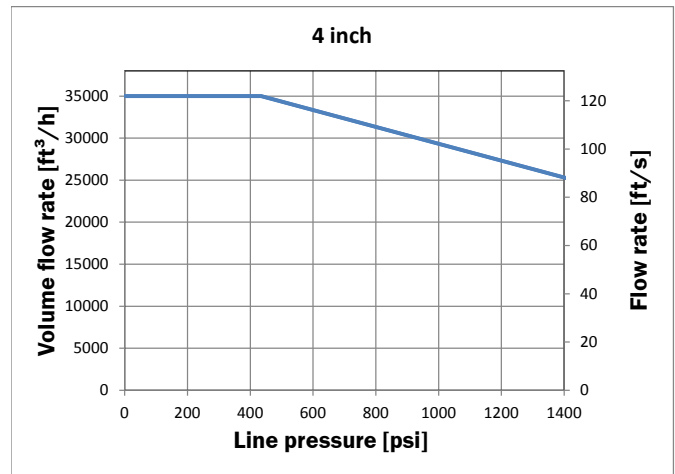
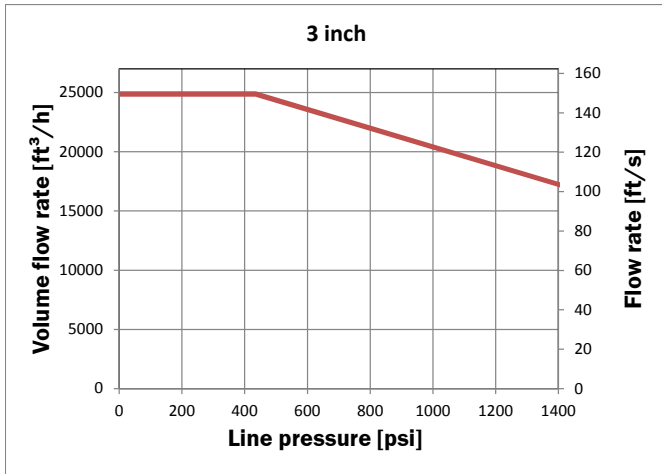

## Corrected Volumetric Capacity

Maximum Corrected Volumetric Capacity at Various Operating Pressures											
Pressure [psig]	50	100	200	300	400	500	600	800	1000	1200	1380
3 inch Volume Flow Rate [MMSCFD]	2.5	4.4	8.3	12.4	16.5	20.4	23.9	30.4	36.1	40.9	44.4
4 inch Volume Flow Rate [MMSCFD]	3.5	6.2	11.7	17.4	23.3	28.8	33.9	43.4	52.1	59.6	65.3

Volumetric calculations based on Amarillo gas compositions (see AGA Report No. 8) flowing at 70°F (Atm Press=14.73 psi)

Calculations based on maximum volume flow rate shown in the graphs „Application Range“

## Installation diagram

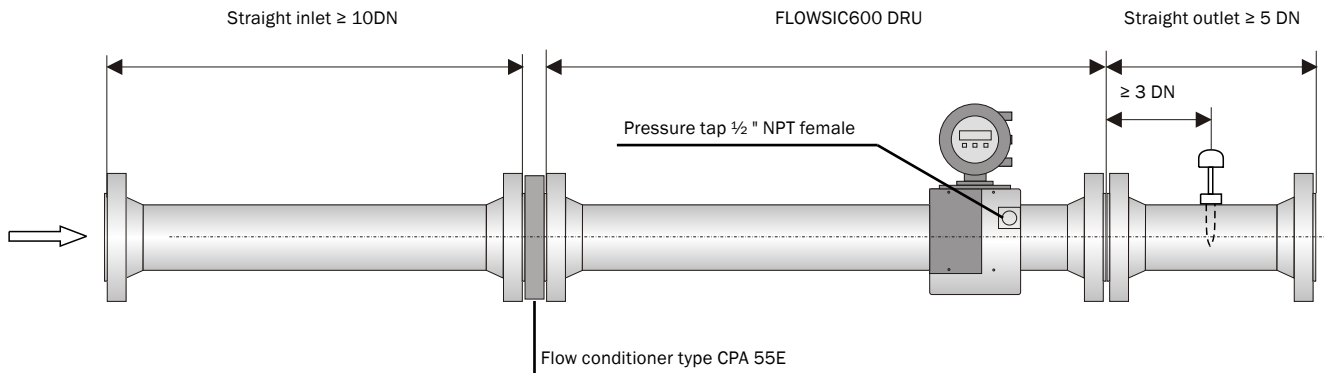



## WWW.MYSICK.COM – SEARCH ONLINE AND ORDER

Search online quickly and safely – with the SICK “Finders”

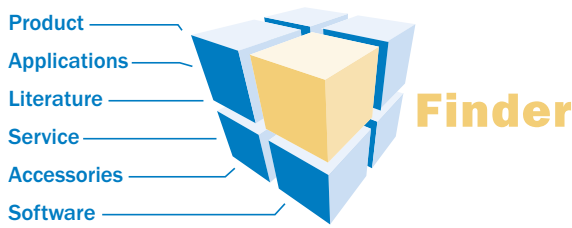

**Product Finder:** We can help you to quickly target the product that best matches your application.

**Applications Finder:** Select the application description on the basis of the challenge posed, industrial sector, or product group.

**Literature Finder:** Go directly to the operating instructions, technical information, and other literature on all aspects of products from SICK.

These and other “Finders” at → [www.mysick.com](http://www.mysick.com)

Efficiency – with the e-commerce tools from SICK

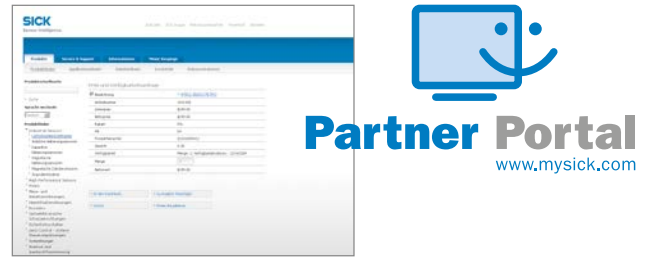

**Find out prices and availability:** Determine the price and possible delivery date of your desired product simply and quickly at any time.





**Request or view a quote:** You can have a quote generated online here. Every quote is confirmed to you via e-mail.

**Order online:** You can go through the ordering process in just a few steps.

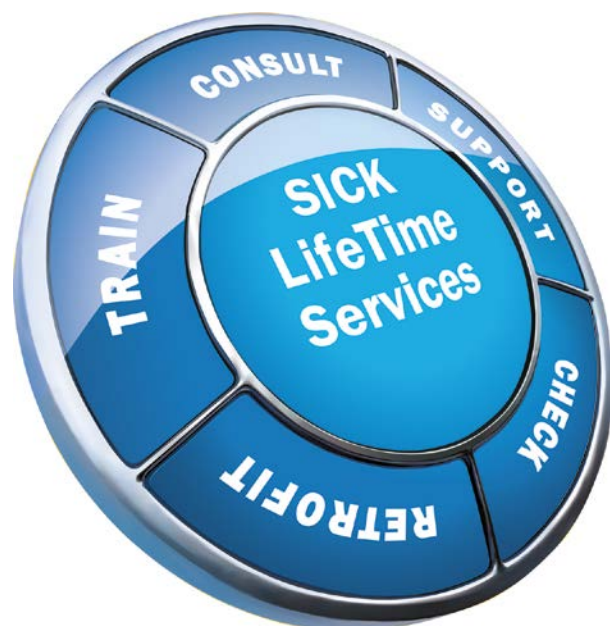
## SERVICES FOR MACHINES AND SYSTEMS: SICK LifeTime Services

Our comprehensive and versatile LifeTime Services are the perfect addition to the comprehensive range of products from SICK. The services range from product-independent consulting to traditional product services.



- 
**Consulting & Design**  
Safe and professional
- 
**Product & System Support**  
Reliable, fast and on-site
- 
**Verification & Optimization**  
Safe and regularly inspected
- 
**Upgrade & Retrofits**  
Easy, safe, economical
- 
**Training & Education**  
Practical, focused and professional

## SICK AT A GLANCE

SICK is a leading manufacturer of intelligent sensors and sensor solutions for industrial applications. With more than 7,400 employees and over 50 subsidiaries and equity investments as well as numerous representative offices worldwide, we are always close to our customers. A unique range of products and services creates the perfect basis for controlling processes securely and efficiently, protecting individuals from accidents and preventing damage to the environment.

We have extensive experience in various industries and understand their processes and requirements. With intelligent sensors, we can deliver exactly what our customers need. In application centers in Europe, Asia and North America, system solutions are tested and optimized in accordance with customer specifications. All this makes us a reliable supplier and development partner.

Comprehensive services round out our offering: SICK LifeTime Services provide support throughout the machine life cycle and ensure safety and productivity.

**For us, that is “Sensor Intelligence.”**

### **Worldwide presence:**

Australia, Austria, Belgium/Luxembourg, Brazil, Czech Republic, Canada, China, Denmark, Finland, France, Germany, Great Britain, Hungary, India, Israel, Italy, Japan, Mexico, Netherlands, Norway, Poland, Romania, Russia, Singapore, Slovenia, South Africa, South Korea, Spain, Sweden, Switzerland, Taiwan, Turkey, United Arab Emirates, USA

Detailed addresses and additional representatives → [www.sick.com](http://www.sick.com)